

# JG-34F

# SOLID STATE RELAY



### Features

- 4000V dielectric strength
- Photo isolation
- Zero cross or random turn-on
- Double SCR AC output
- Panel mount
- DC or AC control

### INPUT

Control voltage range (DC input)	3 to 32VDC
Control voltage range (AC input)	90 to 280VAC
Must operate voltage (DC input)	Max. 3VDC
Must operate voltage (AC input)	90VAC
Must release voltage (DC input)	1VDC
Must release voltage (AC input)	10VAC
Maximum input current (DC input)	25mA (@ 32VDC)
Maximum reverse protection voltage(DC input)	- 32VDC

### DESCRIPTION

The JG-34F offer 3-32VDC or 90-280VAC input control,with outputs rated at 40、50、60 70、 or 80Amps.SCR output provides high dv/dt capability more than 500v/us. All models include an internal snubber. The relays provide 4000Vrms opto-isolation between input and output. Outline dimension is 58.4mmX45.7mmX22.9mm.

### OUTPUT

Max.OffStateLeakageCurrent (at Rated Voltage)	5mA
Max. On-State Voltage Drop (at Rated Current)	1.7Vrms
Max. Turn-on Time	Random Turn-on (DC Input) : 1ms
	Zero Cross Turn-on : 1/2 cycle (DC Input) +1ms
	AC Input Type : 20 ms
Max turn-off time	(DC input) 1ms+ 1/2 cycle
	(AC input) 40ms
Min. off-state (dv/dt)	500V/ μ s

### PRECAUTIONS

- 1、 When choosing a SSR, please notice the actual load current and working ambient temperature. To use the SSR correctly, please refer to CHARACTERISTIC DATA and make sure the heat sink size when it works in full load current.
- 2、 Apply heat-radiation silicon grease of a heat conductive sheet between the SSR and heat sink. There will be a space between the SSR and heat sink Attached to the SSR. Therefore, the generated heat of the SSR cannot be radiated properly without the grease. As a result, the SSR may be overheated and damaged or deteriorated.
- 3、 Tighten the SSR terminal screws properly. If the screws are not tight, the SSR will be Damaged by heat generated when the power in ON. Perform wiring using the tightening torque shown in the following table.

Screw size	Recommended tightened torque
M3	0.58 to 0.98 N·m
M4	0.98 to 1.37 N·m

### GENERAL

Dielectric strength (at 50/60Hz for 1min)	4000VAC 1min.
Insulation resistance	1000MΩ 500VDC
Ambient temperature	Operating -30°C to +80°C
	Storage -30°C to +100°C
Ambient Humidity	45% to 85%
Unit weight	88g



HONGFA RELAY  
ISO9001、 ISO/TS16949 、 ISO14001 CERTIFIED

VERSION: EN02-20040601

## ORDERING INFORMATION

Type	JG-34F / D- 240 A 40 Z S -L					
Input voltage	D: 3 to 32VDC		A: 90 to 280VAC			
Nominal Voltage	240: 48 to 280V		380: 48 to 400V 480: 48 to 530V			
Load Voltage form	A: AC					
Load Current	40: 40A		50: 50A		60: 60A 70: 70A 80: 80A	
Zero Cross Function	Z: Zero cross turn-on		P: Random turn-on			
Output component	S: SCR					
LED indicator	L: With LED		Nil: Without LED			

## OUTLINE DIMENSIONS, WIRING DIAGRAM AND MOUNTING HOLES

### Outline Dimensions

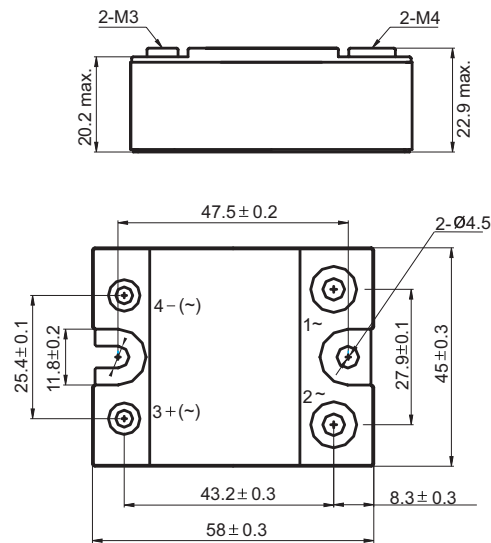

### Mounting hole layout

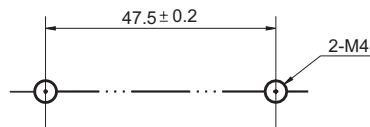

### Schematics

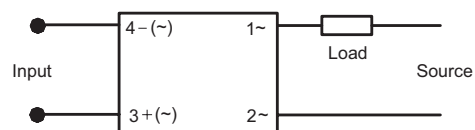

# CHARACTERISTICS CURVE

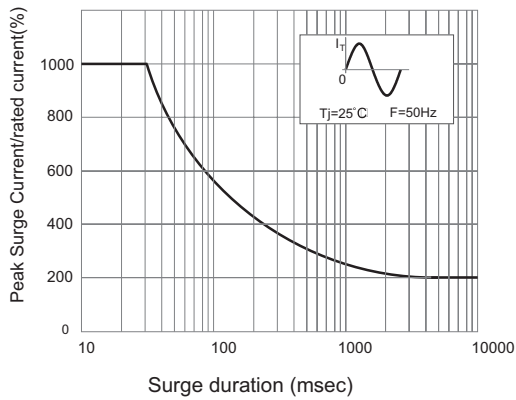

Max.Surge Current vs.duration Time

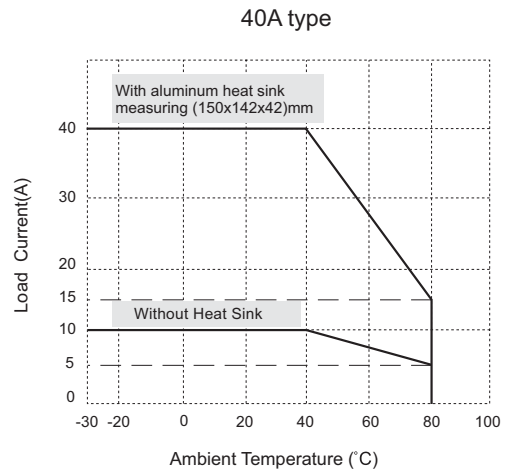

Max. load Current vs. Ambient Temp.

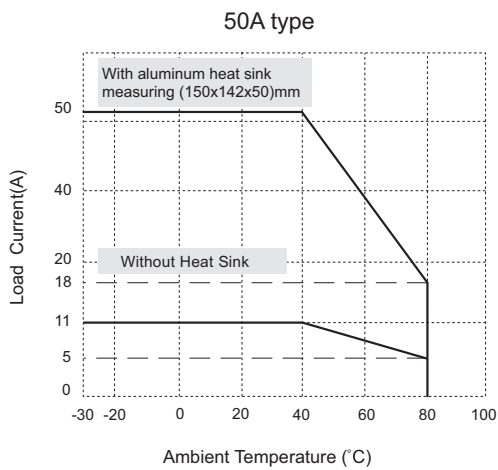

Max. load Current vs. Ambient Temp.

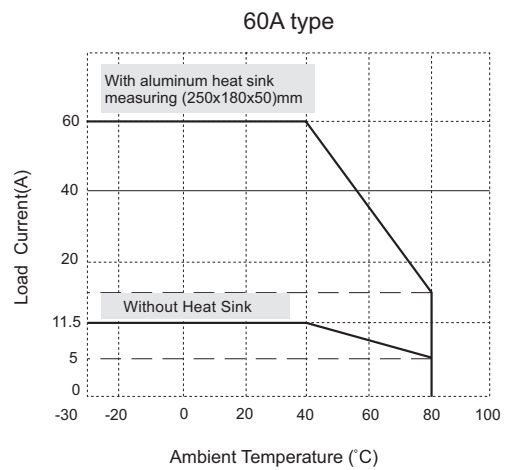

Max. load Current vs. Ambient Temp.

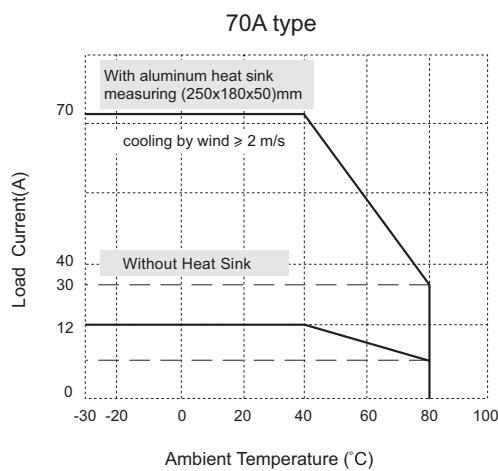

Max. load Current vs. Ambient Temp.

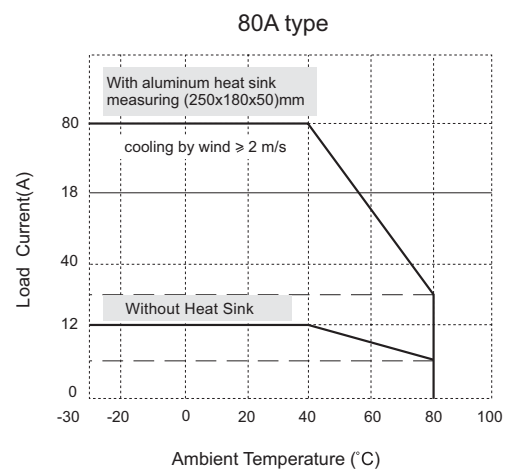

Max. load Current vs. Ambient Temp.